

OTi DALI 50/220-240/24 4CH DT6/8 G3 OTi DALI 80/220-240/24 4CH DT6/8 G3

24 V Multi-channel Constant Voltage LED driver
Dimmable range 0/0,1% - 100%

Benefits

- Long lasting and high reliability.
- DALI-2 DT6 and DT8 features in one driver.
- DT6: 1 – 4 independent channels.
- DT8: TW and RGBW applications.
- Self-configuring channels.
- High efficiency in slim form factor.
- Patent pending flicker-free dimming until 0,1%.

Applications

Hospitality, cove lighting, shops.
Suitable for indoor CLASS I and CLASS II luminaires.

Approvals

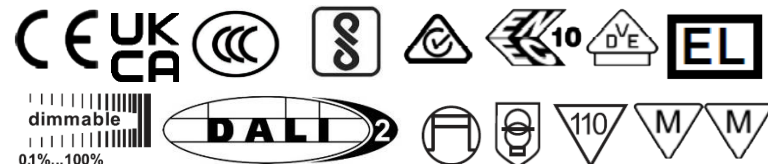

When not printed on product label, they are under evaluation.



Housing material: plastic, white
* image for information purpose only

L	346 mm	Total length
B	32 mm	Width
H	22 mm	Height



Product Features

- DT6: 1 to 4 self-configuring DALI channels
- DT8 TW selectable by dip-switch
- Lamp Failure detection
- CLASS II independent housing
- Smart Power Supply
- SELV, Vout: 24,2 V
- t_a range -20...+45 °C
- Overload, over temperature and short circuit protection
- Dimmable via DALI or Touch DIM
- Very low min dimming level: 0,1 %
- Mains voltage: 220–240 V_{ac} / 176–276 V_{dc}
- 50'000 h lifetime at max t_c*
- 5 years guarantee*
- IP20 independent housing (cable clamp)
- Output wire length up to 50 m
- Double button Touch DIM compatibility
- Emergency lighting compatibility

*10% cumulated failure, 24 h = 14 h ON, 10 h Standby

Electrical specifications

	Item	Value	Unit	Remarks / Condition
INPUT	Nominal line voltage	220 – 240	V	
	Mains line frequency	0 / 50 / 60	Hz	
	AC voltage range	198 – 264	V	Max 350 V for 2 h. Auto switch off > 280 V _{ac}
	DC voltage range	176 – 276	V	
	Nominal current	50 W: 0,24 80 W: 0,39	A	Typical @ full load, 230 V _{ac} , 50 Hz
	Total Harmonic Distortion (THD)	< 5	%	Full load, 230 V _{ac} , 50 Hz, 3 % typ. See graphs
	Power factor λ	50 W: 0,82-0,99 80 W: 0,95-0,99		Range 25 % - 100 % load, 230 V _{ac} , 50 Hz. See graphs
	Efficiency in full load	50 W: 92 80 W: 93	%	Typical, Full load, 230 V _{ac} , 50 Hz, see graphs
	Device power loss	50 W: 4 80 W: 6	W	Full load, 230 V _{ac} , 50 Hz, Typical
	Networked stand-by power	< 0,30	W	230 V _{ac} , 50 Hz. Typical 240 mW
	Protection Class	II		
	Suitable for fixtures with prot. Class	I / II		
	Inrush current	50 W: 41 A _{pk} / 150 μs 80 W: 46 A _{pk} / 190 μs		Full Load, 240 V _{ac} , Cold Start Duration = 50% / 50% I _{pk}
	Max. units per circuit breaker:	50 W 80 W	Model	
	Max. ECG no. on circuit breaker 10 A (B)	13 9		B-Type is underusing thermal protection
	Max. ECG no. on circuit breaker 16 A (B)	21 15		
	Max. ECG no. on circuit breaker 25 A (B)	33 23		
	Max. ECG no. on circuit breaker 10 A (C)	22 15		C-Type is the preferable MCB choice
	Max. ECG no. on circuit breaker 16 A (C)	36 25		
Max. ECG no. on circuit breaker 25 A (C)	56 39			
Max. ECG no. on circuit breaker 10 A (D)	29 17		D-Type is underusing short-circuit protection	
Max. ECG no. on circuit breaker 16 A (D)	46 28			
OUTPUT	Nominal voltage	24,2	V	
	Voltage accuracy	± 2	%	
	Voltage ripple	< 1	V _{pp}	@ 100 Hz, full load. Typical < 500 mV _{pp}
	Nominal output power	50 W: 0 – 50 80 W: 0 – 80	W	Power factor, harmonics and EMI guaranteed between: 50 W: 18 – 50 80 W: 30 – 80
	Maximum output power (at steady state)	50 W: 50 80 W: 80	W	Smart Power to manage up to P _{out_max} +25 % Full load on one channel only is allowed
	Minimum load for channel autodetection	0,25	W	One single SEU is typically detected
	DC Output power (EL)	15	%	
Galvanic isolation	SELV		When using for PELV, do connect the "+" to PE	
DIMMING	Dimming interface	DALI 2.0		Proper DALI diagnostics with a min. load of 9 % (4.5 / 7.5 W) per channel and dimming > 3 %
	Dimming range	0,1 – 100	%	DALI dimming steps (0 – 254)
	Dimming method	PWM		
	TLA (Flicker and strobe effects)	P _{ST} < 1 SVM < 0,4	-	For every dimming condition (n.a. < 1 %) Extended SVM metrics (10 kHz).
	Galvanic Isolation	Basic / Double		Basic DALI to PRIM / Double DALI to SEC
ENVIRONMENTAL	Ambient temperature range	-20...+45	°C	
	Max. temperature at T _c test point	50 W: 70 80 W: 85	°C	Measured on t _c point indicated of the prod label, t _a not exceeded
	Max. case temperature in fault condition	115	°C	
	Storage temperature range	-40...+85	°C	
	Permitted rel. humidity during operation	5 – 85	%	Not condensing
	Surge capability	1 2	kV	L to N according to EN 61547 L+N to GND plane
	Environmental rating	Indoor		
	IP protection class	IP 20		
	Mains switching cycles	> 100000	cycles	
	Expected ECG lifetime	30000	h	@ t _a = 45 °C, t _c MAX and 10 % failure rate, always ON
		50000	h	@ t _a = 45 °C, t _c MAX and 10 % failure rate, 14 h ON and 10 h stand-by per day
	100000	h	@ t _c = 10 °C and 10 % failure rate, 14 h ON and 10 h stand-by per day	

Item	Value	Unit	Remarks / Condition
No-load proof	Yes		Auto recovery
Intended for no-load operation	No		
Overheating protection	Yes		Auto recovery
Overload protection	Yes		Auto recovery + Smart Power
Short-circuit protection	Yes		Auto recovery
DIMENSIONS	Height	22	mm
	Length	346	mm
	Width	32	mm
	Weight	380	g
	Mounting holes interaxis	303	mm
	Casing material	Plastic	
	Type of connection	Screw terminals	
	Wire preparation length	6 / 5	mm

Protection

Over temperature, Overload, Short-circuit, Input overvoltage, Output overvoltage. Reversible.

Full load on one-channel-only operation is allowed.



DIP switch for DT6 or DT8 TW selection

- Input wires cross section: 0,5 – 2,5 mm². Screw driver: 3,5 mm
- Output wires cross section 0,2 – 1,5 mm². Screw driver: 2,5 mm
- Wire peeling: input 6 mm, output 5 mm

LED wire length

The wire length from the ECG to the LED module can reach 50 m with verified EMI.

Below matrixes show the maximum LED load power according to cable length and section, at 25 °C.

The proper wire section will ensure that the LED module input voltage is at least 23 V in the single-load worst condition.

V _{out} 24,2V / nominal 50 W	Cable length [m]							
	AWG	mm ²	5	10	20	30	40	50
Cable section	18	0.75	50	50	29	19	15	12
	17	1	50	50	39	26	19	16
	16	1.5	50	50	50	39	29	23
	14	2.5	50	50	50	50	48	39
	12	4	50	50	50	50	50	50

V _{out} 24,2V / nominal 80 W	Cable length [m]							
	AWG	mm ²	5	10	20	30	40	50
Cable section	18	0.75	80	58	29	19	15	12
	17	1	80	78	39	26	19	16
	16	1.5	80	80	58	39	29	23
	14	2.5	80	80	80	64	48	39
	12	4	80	80	80	80	77	62
	10	6	80	80	80	80	80	80

Values are indicative. Each connection may increase total voltage drop.

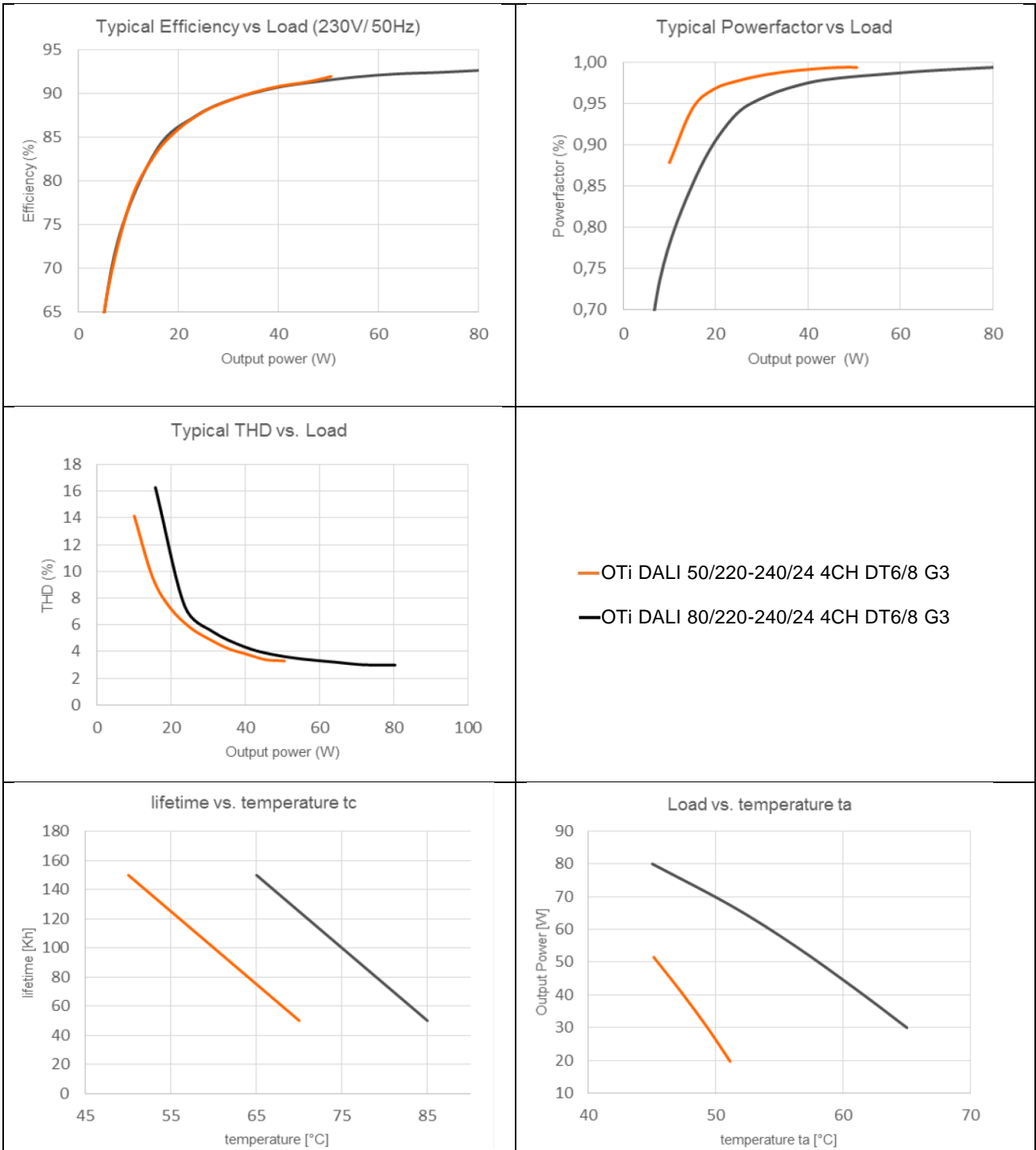

Channel addressing procedure (DT6 / DT8 TW)

AUTO ADDRESSING ON FIRST POWER UP

The ECG performs auto-channel-detection on first power up when set to DT6 operation (dip-switch: on).

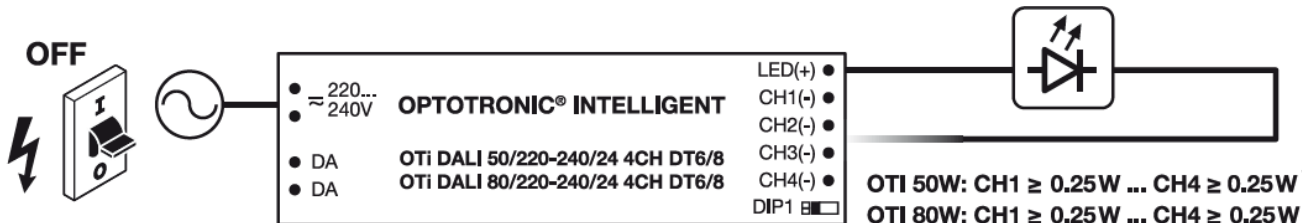

1. Connect the LED loads to the desired channels from 1 to 4.
2. Select “Device Type” to with the dip-switch: DIP-SW ON: DT6 (default) – DIP-SW OFF: DT8 TW

DT8 in TW mode allows using only CH1 (Cold) and CH2 (Warm) outputs.
For DT8 in RGBW mode T4T is needed, see printing on product for channel connection to LED load

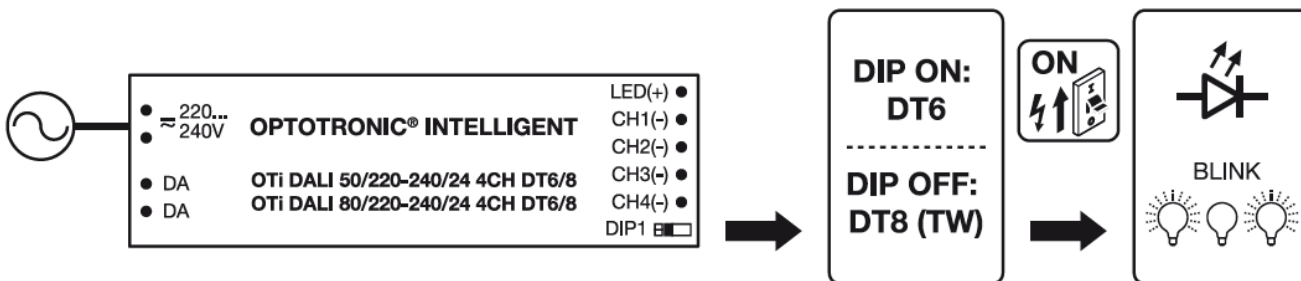

3. Connect the ECG to the mains: the LED loads start blinking.
4. After blinking stops, a DALI address has been assigned to each detected load.

Notes: in DT6 mode there is no need to connect the first load to CH1, nor to fill sequentially the terminals: the addresses will be assigned orderly just according to the detected loads, e.g. connecting to CH2 and CH4 will generate two DALI addresses. The outputs not connected to any load during the autodetect phase will stay off and won't get a DALI address.

ADDRESSING ERROR FIXING OR RESET

Every time the driver recognizes a dip-switch operation (from ON to OFF or vice-versa) it resets its channel configuration. In case DT6 addressing is newly required, the autodetection sequence can be restarted. In order to recognize the change, the driver must be active (powered, not stand-by) during or after each dip-switch operation.

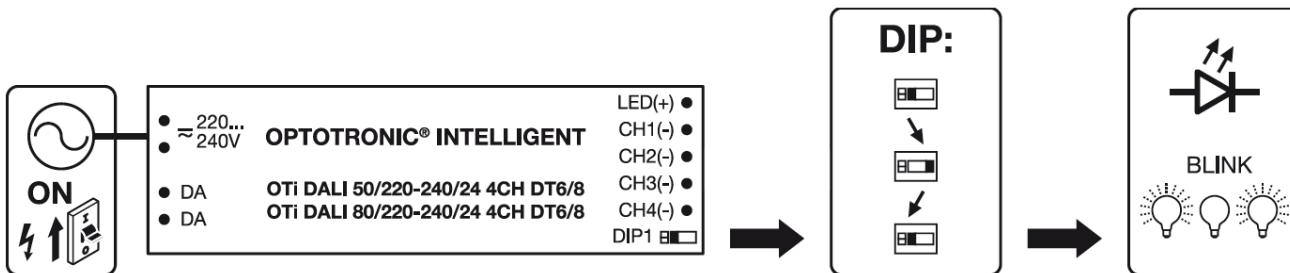

For instance, in order to reconfigure the driver for a new DT6 load configuration, after connecting or disconnecting new loads, move the dip-switch from ON to OFF, then from OFF to ON, during power-on or powering on after each operation.

Tunable White (TW) DALI-2 DT6 and DT8 modes

These drivers can operate in TW operation under DALI-2 Device Type 6 or Device Type 8 mode.

DALI-2 DT6 needs two DALI addresses to operate in TW, one for warm white channel and one for cool white channel, while DALI-2 DT8 only needs one address for two channels.

DT6 mode allows LED load to be fully powered using 100 % of its rated output. At fixed dimming condition, shifting from one CCT to the other will have impact on output luminous flux.

DT8 mode will prevent luminous flux alteration when moving through CCTs at the same dimming condition but **limited to this setting the devices are able to support nominal power output (50 – 80 W) on each one of the two connected channels.**

Refer to below graphs to understand driver behavior on output power and luminous output of connected LED load.

Always make sure the DALI Master (if used) in the installation supports the designed DALI-2 “Device Type” mode.

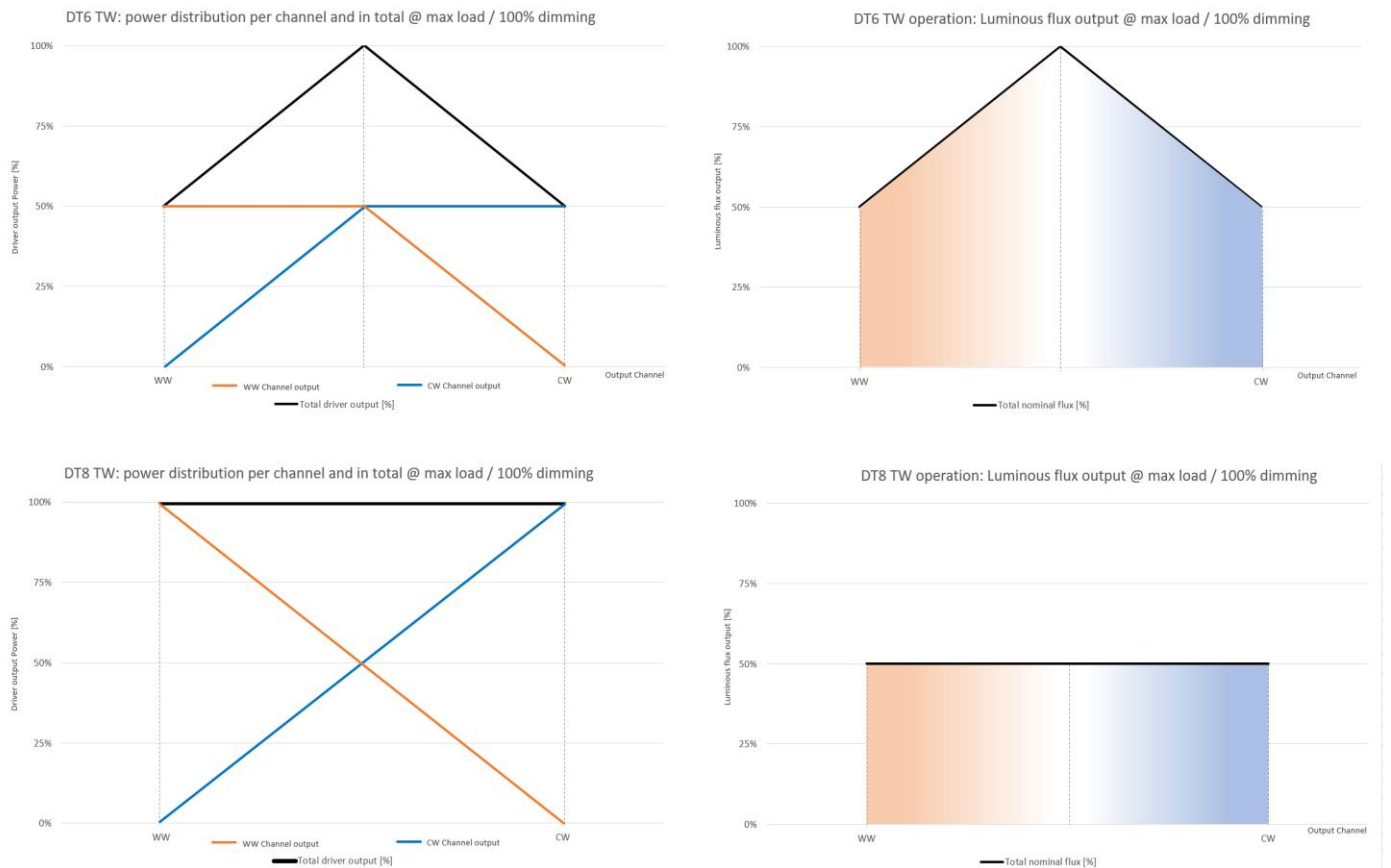

Driver programming

Connecting the drivers to OSRAM T4T tool (dip-switch override) allows the following programming options:

- Autodetected independent 1 to 4 channels DT6 – One address per found channel (factory default)⁽¹⁾.
- Preset fixed independent 1 to 4 channels DT6 – One address per programmed channel.
- One DALI address, DT8 tunable white (TW).
- One DALI address, DT8 RGBW.
- One DALI address, DT6 4 synchronized channels (SYNC).
- One DALI address, DT6 Dim to Warm
- * Touch DIM, 1-4 synchronized channels (DT6 default with 1, 3 or 4 channels, 1st push-button only).
- Touch DIM, 2 synchronized channels.
- * Touch DIM, 2 independent channels (DT6 default with 2 channels, 1st and 2nd push-button use).
- * Touch DIM TW (DT8 default, 1st push-button for brightness and 2nd push-button for color).
- Touch DIM, Dim to Warm.
- Corridor function, 4 synchronized channels (SYNC).

*: These are factory default configuration modes and do not require initial DALI programming by T4T, they are simply selected and kept once the external buttons are recognized (1st button Long Press, 5 s without DALI frames after last turn-on). All the other operating modes need specific programming by the T4T application via DALI connection.
 (1): Only the autodetection allows arbitrary use of output terminals as above described. If a fixed number of channels is programmed by the T4T, the autodetection is disabled and the output terminals must be used in their assigned order.

Single and double Touch DIM

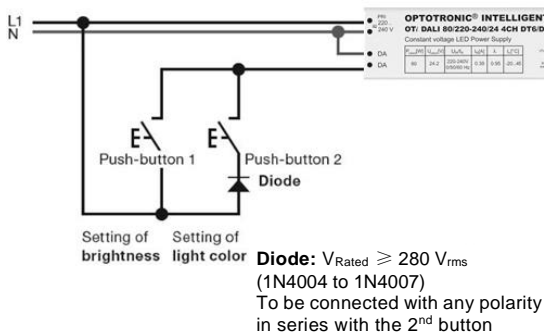

This driver supports single and double button Touch DIM operation. The 2nd button must be connected in parallel with the 1st by means of a diode. As per factory default configuration, the Touch DIM mode is auto-detected and stored through a Long Press of the 1st button; the operation is as follows:

- The 1st button to control the dimming level.
- The 2nd button to change the CCT mixing (DT8 TW) or the second channel level (DT6 independent).

Additional information

- The Touch DIM input voltage ranges from 10 Vac to 264 Vac and has single insulation from mains.
- DALI and Touch DIM must never be used at the same time: control is achieved either with DALI controller or with the Touch DIM function (self-recognized or previously programmed via DALI).
- Up to 20 ECGs can be controlled via direct push-button use. The number of push-buttons is limited by the sum of the overall cable length between switch(es) and the connected ECGs: maximum length should not exceed 25 m. In case of longer distances, a small transformer or a DALI repeater must be used to overcome line capacitance; this transformer cannot be used in case of rectified second button usage.
- For additional features, the button operation can be configured by means of the T4T application.

Touch DIM operation

The following item-list briefly describes the use of push-button for brightness control (1, 2 or SYNC CH):

- Switching the lamp on/off: Short Press (< 0,5 s).
- Dimming: Long Press (> 0,5 s); the dimming direction is changed with each press.
- Store reference value: double-click (press twice within 0,4 s) while lamp is *On* → Switch to *Mode 2*.
- Delete reference value: double-click while lamp status is *Off* → Switch to *Mode 1*.
- Long Press while lamp status off: the lamp is switched on at the minimum dimmer setting and faded up until the push-button is released.

In case of CCT Control (2nd button in TW mode), operation is similarly replicated but for white color temperature:

- Short Press: sets the color temperature to mid of scale and the shift direction to warmer.
- Long Press: shifts color; the shifting direction is changed with each press.
- Double Press: sets *Mode 2* for color if lamp is on, or *Mode 1* if lamp is off (color blink confirmation).

Operating Modes

- Mode 1: the switch-on value is always the last brightness/CCT before the lighting was switched off.
- Mode 2: the switch-on value is the value stored by double clicking (default mode).

Re-synchronization

In case of many ECGs connected to the same Touch DIM buttons, there is a chance that an ECG will operate out of synchronism with the others (different on/off state, dimming level or CCT/color).

To have all of them back in synchronism, just apply a Long – Short – Long sequence, and in case apply a double-click afterwards to store a new common reference level. Short press on PB2 re-synchronize CCT/color.

Programming

Several parameters of Touch DIM can be programmed by T4T, for instance the Corridor Function, dimming limits, fading times, enable/disable functions, etc.

Light sensors

The Touch DIM system enables using Presence Sensors and/or Light Sensor directly connected to the DALI terminals. For such an application, please refer to OSRAM on-line documentation and catalogue.

Remarks

- **Product performances below minimal load condition:** the output power is still generated if the total load is below the minimum output power (18 W for OTi DALI 50 and 30 W for OTi DALI 80, on single channel or distributed in different channels), without any safety risk, but performances regarding THD, EMI, etc. are not guaranteed. See typical operation window graph for details.
- **Output short circuit protection:** the short circuit current is limited without damaging the unit. The short circuit protection is self-restoring.
- **Output overload protection:** in case of overload (< 125 %), the device automatically dims down the output to keep the average power within 50 W (for OTi DALI 50) or 80 W (for OTi DALI 80) and let the LED load warm-up. When the load exceeds the 125% of maximum nominal output power, the LED load will blink to manifest a fault condition, till the short circuit limit (> 200 %).

- **Input over voltage protection:** the ECG is capable of having input of max 350 V for 2 hours. To prevent damages to the unit, driver performs auto switch off when input voltage is $> 280 V_{ac}$, therefore driver operation in this abnormal condition is not guaranteed. The over voltage protection is self-restoring.
- **Lamp failure detection:** the minimum load on channel which enables the open circuit detection is 4.5 W (for OTi DALI 50) or 7.5 W (for OTi DALI 80). If the load is found below this threshold during the autodetection, the “Open load” flag will be never activated for that specific channel. This prevents false alarm signaling when installing very low loads, which are anyhow detected.
- **No load operation:** do not put a switch between ECG and load.
- **Over temperature protection:** the driver is protected against temporary overheating, so it automatically dims down when t_c is exceeded, and eventually turns off. The protection is self-restoring.
- **Emergency lighting:** this LED power supply is suitable for emergency lighting fixtures acc. to EN 60598-2-22, with emergency default output factor EOFI = 0,15. The value is programmable up to EOFI = 1 with P_{max} 12 W and related duration time of 10 h at least. Function in emergency is ensured up to $t_a = 80^{\circ}C$ and $t_c = 96^{\circ}C$.
- **Ecodesign regulation information:**
Intended for use with LED modules only. Separated control gear and light sources must be disposed of at certified disposal companies in accordance with Directive 2012/19/EU (WEEE) in the EU and with Waste Electrical and Electronic Equipment (WEEE) Regulations 2013 in the UK. For this purpose, collection points for recycling centers and take-back systems (CRSO) are available from retailers or private disposal companies, which accept separate control gear and light sources free of charge. In this way, raw materials are conserved and materials are recycled.

Standards

EN-55015
EN 61347-1
EN 61347-2-13
EN 61547
EN 61000-3-2
EN 60598-2-22
EN 62384
EN 62346

Ordering information

Product name	EAN 10	EAN 40	Pieces / Box
OTi DALI 50/220-240/24 4CH DT6/8 G3	4062172274289	4062172274296	20
OTi DALI 80/220-240/24 4CH DT6/8 G3	4062172274302	4062172274319	20

Inventronics GmbH

Head Office:
Parkring 31-33
86574 Garching, Germany
Phone +49 89 6213-0
www.inventronicsglobal.com

inventronics
OSRAM Digital System is now Inventronics