

OT FIT 36/220-240/24 PC

Constant Voltage LED Phase Cut Dim Driver

Benefits

OPTOTRONIC® LED Power Supply with high reliability in extra small & compact housing.
 24 V constant output voltage and dimmable output current.
 Recommended to use with electronic trailing edge dimmer
 5 years guarantee

Applications

Hospitality – decorative lighting, night light
 Restaurants – decorative lighting
 Shops – decorative lighting, shelf lighting
 Residential – cove lighting, cabinet lighting

Approvals



Valid only if printed on product.
 When not printed on product label, they are under evaluation.

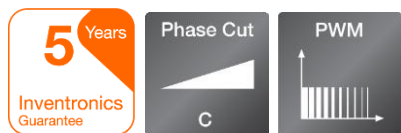

Housing material: plastic, white
 * image for information purpose only

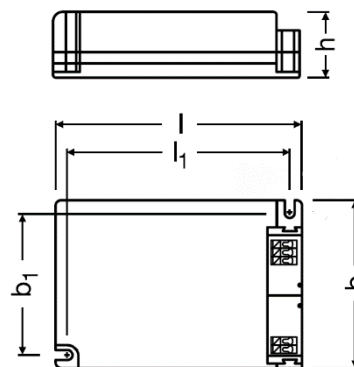

L	103 mm	Total length
W	67 mm	Width
H	29.5 mm	Height
L1	94 mm	Holes interaxis
B1	58 mm	Holes interaxis

Product Features

- 24 V SELV output constant voltage output
- Output Current: 0.1 A ~ 1.5 A
- Output Power: 2.42 W ~ 36.3 W
- Typical Efficiency: 85%
- Recommended to Use Trailing Edge dimmer
- Suitable for Class I & II luminaires
- Wide T_a range -20 ... +50 °C
- 50.000h* at T_c max

*10 % cumulated failure

Electrical specification

	Item	Value	Unit	Remarks
INPUT	Nominal supply voltage	220 - 240	V _{AC}	
	Nominal frequency	50 / 60	Hz	
	AC voltage range	198 - 264	V _{AC}	Permitted voltage range
	Maximum voltage	300	V	2 hours maximum, No damage to LED module
	Nominal current	190	mA	Full load, 230 V, 50 Hz, typical
	Total Harmonic Distortion (THD)	< 15	%	Full load, 230 V, 50 Hz
	Power factor	0.45C...0.98		Nominal output power range, 230 V, 50 Hz
	Efficiency in full-load	85	%	Full load, 230 V, 50 Hz, typical
	Power loss	6	W	Full load, 230 V, 50 Hz, typical
	Protection class	II		With cable clamp
	Inrush current	<25	A	t _{width} = 250 μs typical (measured at 50% I _{peak})
	Max. units per circuit breaker	B16: 33 B10: 21 C16: 53 C10: 33		
	Touch current	< 0.7	mA	Output floating
OUTPUT	Average nominal output Voltage	24.2	V _{DC}	
	Output Voltage Tolerance	+/- 0.8	V	
	Output Voltage Low Freq Ripple	< 5	%	230 V, 50 Hz with 100% Dimming
	Rated output current	0.1- 1.5	A	
	Output Current Low Freq Ripple	< 5	%	230 V, 50 Hz with 100% Dimming
	P _{st} LM	≤ 1.0		Full load with 100% Dimming
	SVM	≤ 0.4		Full load with 100% Dimming
	Nominal output power	2.42 – 36.3	W	Partial Load. Refer to Table 1 for details
	Maximum output power	36.3	W	Ta =50 °C; at steady state
	MM mark	No		
	Galvanic isolation	SELV		Output to mains
DIMMING	Dimming control	Yes		Compatible with leading and trailing edge dimmer
	Dimming range	3-100	%	With LEDDIM 400
	Dimming technique	Leading & Trailing edge		Recommended to use trailing edge dimmer
	Dimming output frequency	>3	kHz	
	Noise level	< 22 dB(A)		at any dim level, microphone 20 cm on top of the driver, with Trailing dimmer: LEDDIM 400
ENVIRONMENT	Ambient temperature range ta	-20 ... +50	°C	
	Maximum case temperature tc	80	°C	
	Max. case temp. in fault condition	110	°C	
	Storage temperature range	-20 ... +80	°C	Cool down before operating
	Relative humidity	5 ... 85	%	Not condensing
	Surge transient protection	1 2	kV	L/N LN/PE acc. IEC 61547
	Environmental rating	Indoor		
	IP rating	IP 20		
	Product weight	162	g	
	Mains switching cycles	> 100'000		
	Expected lifetime	50'000	hrs	T _c max with 10% failure rate

Product drawing

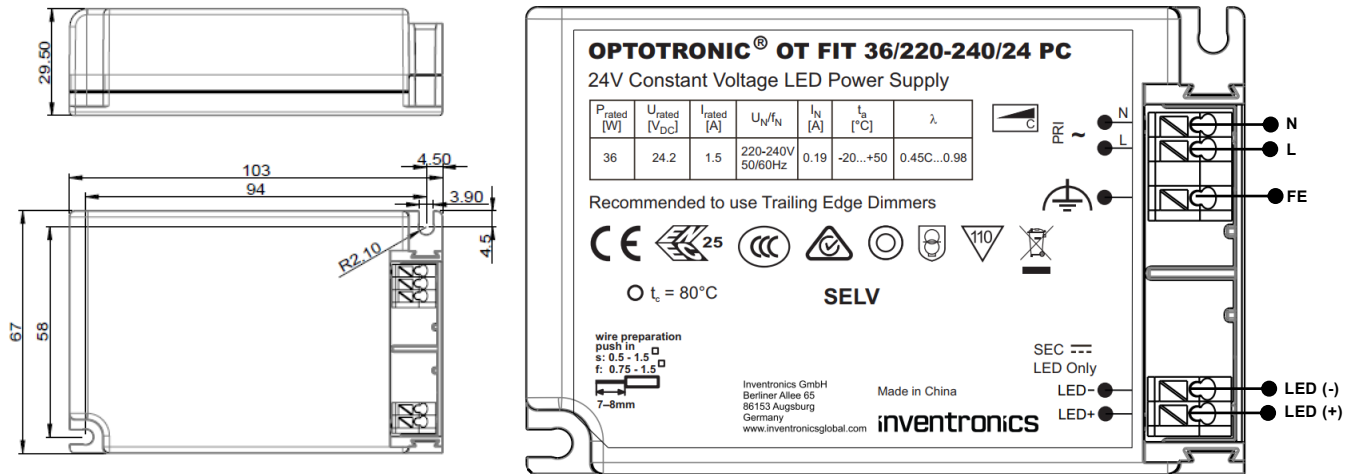

INPUT	Terminals	Wago 255 or equivalent		
	Wire peeling length	7 - 8	mm	
	Cable cross section	0.5 – 1.5	mm ²	Recommended cables for AC input: NYM-J 5x1,5 NYM-J 4x1,5 NYM-J 3x1,5 H05 VV-F 3x1,5 H05 VV-F 3x1 H05 VV-F 3x0,75
OUTPUT	Terminals	Wago 255 equivalent		1 LED+ / 1 LED-
	Wire peeling length	7 - 8	mm	
	Cable cross section	0.75 – 1.5	mm ²	Recommended cables: NYM-J 5x1,5 NYM-J 4x1,5 H05 VV-F 3x1,5 H05 VV-F 3x0,75 H05 VV-F 2x1 H03 VV-F 3x0,75 2xAWG 22 jacketed cable E14800 2xAWG 22 single wires E254881



Remarks:

- For built-in 0.5~1.5 mm², and for independent 0.75~1.5 mm².
- For every saving, power on the driver without LED load and secondary switching is not allowed.
- $t_{amb} > 105^{\circ}\text{C}$ Use heat resistant supply cables, interconnecting cables or external wiring, having $T \geq 105^{\circ}\text{C}$.

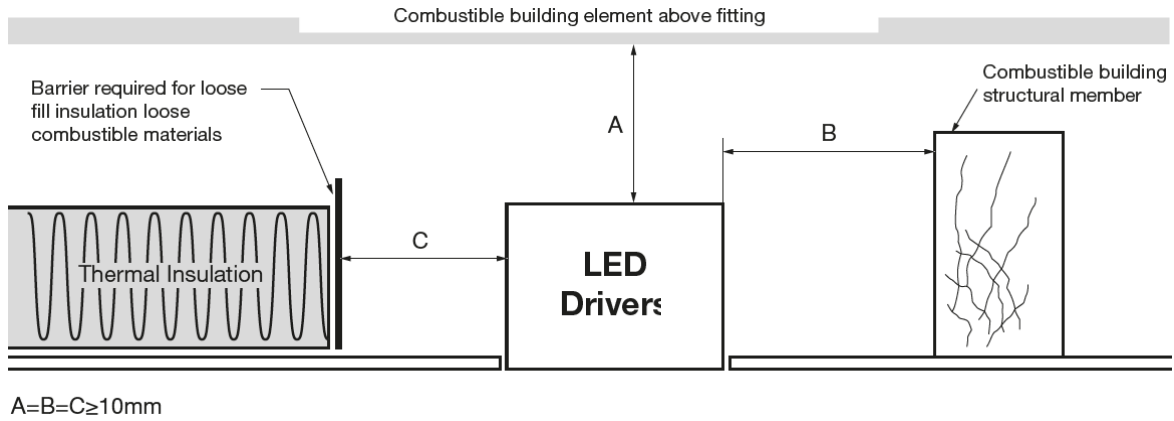
Installation Guide

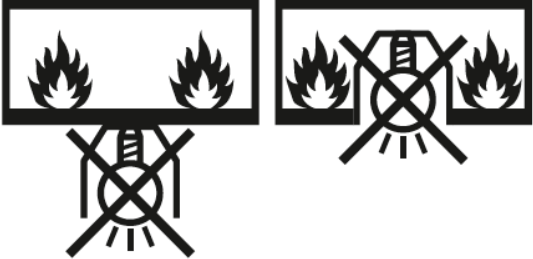

The minimum clearance distance from the top and sides of the control gear to normally flammable building elements is A=B=C ≥ 10 mm, this clause does not apply when the LED driver is built-in the luminaries (for Australia and New Zealand).

Safety information for independent installation and use ¹²⁾		
	suitable for direct mounting in/on normally flammable surfaces ¹³⁾ 	not suitable for direct mounting in/on normally flammable surfaces ¹⁴⁾ 
t_c	t_c < 75 °C	75 °C ≤ t_c ≤ 80 °C

Typical efficiency vs Load (230 V/50 Hz)

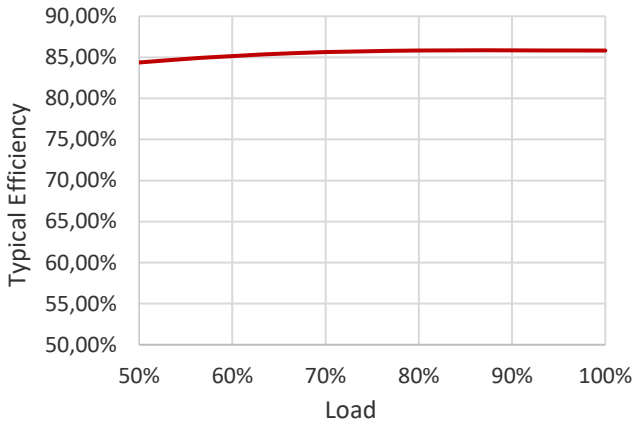

Power Factor vs Load (230 V/50 Hz)

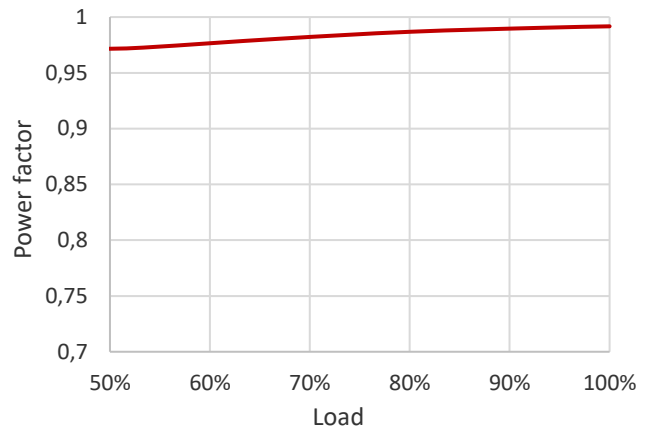

THD vs Load (230 V/50 Hz)

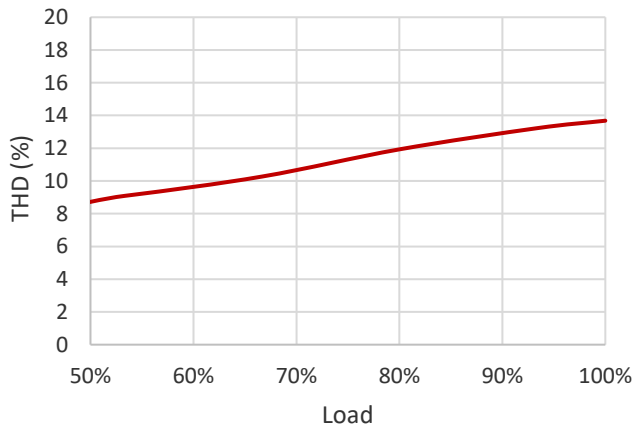

OT FIT 36/220-240/24 PC

Lifetime vs Tc

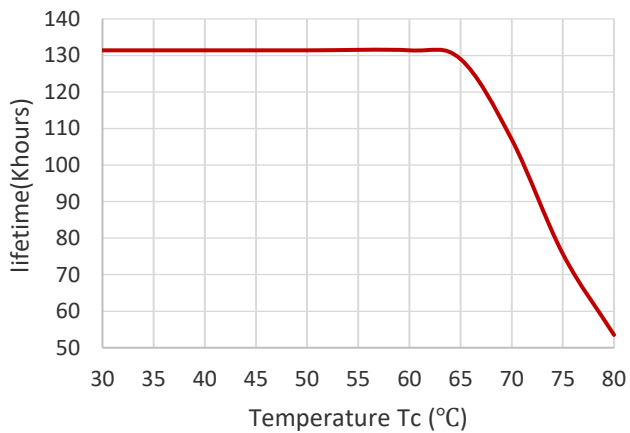

Load vs temperature Ta

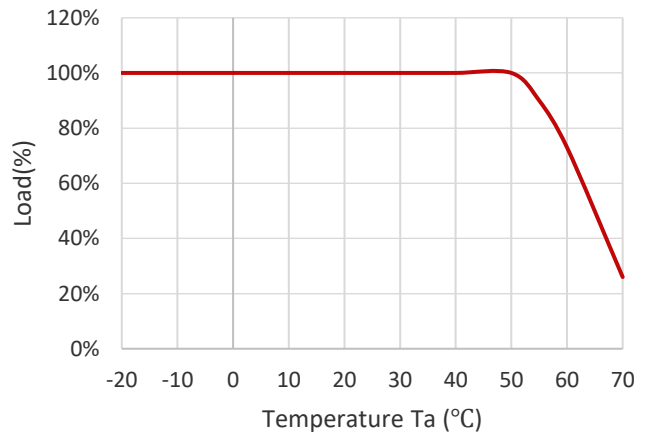

Led wire length

EMI pass verified with wire length below 3 m.

Specifically, for 24 V applications, table below suggests the proper wire section for each cable length to ensure that the LED module input voltage is at least 23 V. Some combinations of cable length / section don't allow full power output. See below table for reference.

Vout 24 V	Cable length [m]							
	AWG	mm2	5	10	20	30	40	50
Cable section	20	0.5	36	36	20	13	10	8
	18	0.75	36	36	30	20	15	12
	17	1	36	36	36	27	20	16
	16	1.5	36	36	36	36	30	24
	14	2.5	36	36	36	36	36	36
	12	4	36	36	36	36	36	36
	10	6	36	36	36	36	36	36
	8	10	36	36	36	36	36	36

Values are indicative at ta 25 °C. Each connection may increase total voltage drop.

Dimmer Capability Matching List

No	Dimmer Brand	Dimmer Model Name	Dimmer Type	Remark
1	SG	LEDDIM 400	T	
2	Busch	6523U	L	
3	Clipsal	32E450UDM	L	
4	Clipsal	32ELEDM	T	
5	ELKO	316 GLED	L	
6	Legrand	67083	L	Only Full loading
7	Legrand	770062	T	
8	Legrand	Cat 400L	L	Only Full loading
9	Legrand	Cat 200L	L	Only Full loading
10	Legrand	Cat 400T	T	Only Full loading
11	NIKO	310-01900	L	
12	NIKO	310-02800	T	
13	V-PRO	250W MAX. GLS	T	
14	Siemens	5UH8222-3NC 05	L	Only Full loading
15	DIGINET	MEDM/LED Smart phase adaptive dimmer 400W	T	
16	DETA	6021	L	Only Full loading
17	rako	RMT-500	T	Minimum brightness from off: 8%
18	rako	RML-500	L	Little flicker at 50%
19	rako	RAK4-T	T	
20	rako	WMT-400	T	Minimum brightness from off: 11%

Remarks:

- L means Leading edge; T means Trailing edge.
- Leading edge dimmers tend to deliver buzzing noise to the system. Acceptance level of this noise is left to customers according to system composition and devices location. Therefore, trailing edge dimmers are suggested.

Protection

Over temperature, Overload, No-load, Short-circuit, Output overvoltage

Remarks

- **Output short circuit protection:** auto reversible when fault removed
- **Output overload protection:** auto reversible when fault removed
- **Output overvoltage protection:** auto reversible when fault removed, Limitation of Output voltage < 60V
- **Over temperature protection:** the unit is protected against temporary overheating by shutting the unit down, auto reversible when temperature decreases
- **Application:** the driver is intended to manage 24 V LED light sources like – but not limited to – Inventronics LINEARlight FLEX®, Tec Flex LED flexible strips, GinoLED Flex LED flexible strips, Value Flex LED flexible strips, Inventronics BackLED® and BoxLED® modules.
- **No-load conditions:** hot plug-in or secondary switching of LEDs is not permitted.
- Intended for use with LED modules.
- The forward voltage of the LED light source shall be within the defined operating window of the control gear in all operating conditions including dimming if applicable.
- The lamp control gear relies upon the luminaire enclosure for protection against accidental contact with live parts.
- ☉ Electronic control gear with double or reinforced insulation
- It is suggested to keep the side and top of the driver at sufficient distance from other surfaces or other devices to avoid overheating. The control gear cannot be installed against or covered by normally flammable materials or used in installations where building insulation or debris is, or may be, present in normal use.
- For Energy saving, please do not power on the driver without LED load and secondary switching is not allowed.
- **Recommendations on how to dispose of it at the end of its life in line with Directive 2012/19/EU:**
Separate control gear and light sources must be disposed of at certified disposal companies in accordance with Directive 2012/19/EU (WEEE) in the EU and with Waste Electrical and Electronic Equipment (WEEE) Regulations 2013 in the UK. For this purpose, collection points for recycling centers and take-back systems (CRSO) are available from retailers or private disposal companies, which accept separate control gear and light sources free of charge. In this way, raw materials are conserved, and materials are recycled.
- **Ecodesign regulation information:**
Intended for use with LED modules. The forward voltage of the LED light source shall be within the defined operating window of the control gear in all operating conditions including dimming if applicable.
Separate control gear and light sources must be disposed of at certified disposal companies in accordance with Directive 2012/19/EU (WEEE) in the EU and with Waste Electrical and Electronic Equipment (WEEE) Regulations 2013 in the UK. For this purpose, collection points for recycling centers and take-back systems (CRSO) are available from retailers or private disposal companies, which accept separate control gear and light sources free of charge. In this way, raw materials are conserved, and materials are recycled.

Standards

EN 61347-1
EN 61347-2-13
EN 55015
EN 61547
EN 60598-1
EN 62384
CISPR 15

Ordering information

Product name	EAN 10	EAN 40	Pieces / Shipping carton
OT FIT 36/220-240/24 PC	6977770438460	6977770438477	30

Optional accessories* (*For independent application)



OT CABLE CLAMP B-STYLE
6977770432147

Inventronics S.r.l.
Via Castagnole 65/A
31100 Treviso
Italy
www.inventronicsglobal.com

inventronics