

OTi DALI 150/220-240/1A0 D NFC IND L

Constant current LED driver w NFC incl. DiiA DALI data – non isolated
Wide operating area up to 1000mA, 1...100% dimmable

Made for Industry applications

Very high robustness, reliability, operating area & energy saving potential, DALI dimmable & programmable, embedded corridor functionality and advanced TouchDIM with daylight harvesting, constant lumen output, enhanced options like Driver Guard / Soft Switch Off / Dim to Dark. DALI & NFC (wireless) interface for fast programming.

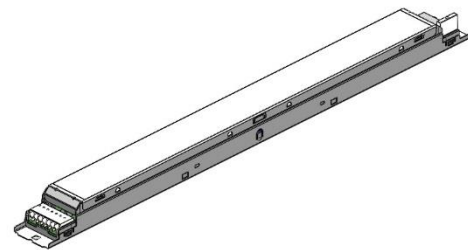

Benefits

Wide operating range: 250 – 1000 mA , 64 – 300 V
Wide ambient temperature range: -40...+65 °C
Programmable via DALI or NFC
In-rush current limiter integrated
Extreme long lasting & high reliability (Industry application)
4kV surge capability (symmetric and asymmetric)
DiiA -251, -252 and -253 integrated
Suitable for emergency lighting units
Smart analogue dimming 1...100%
DALI2 certified

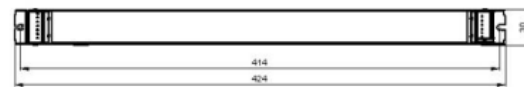

Housing material: metal, white painted

Applications

Linear and Highbay industrial lighting
Trunking systems – Battens – Light Lines – Waterproof - Highbay

Product Features

- 150W output current range 250 – 1000 mA
- 100'000 h lifetime at $t_c = 75^\circ\text{C}$
- Analogue dimming down to 1%
- Very high efficiency up to 95.5%
- In-rush current limiter integrated
- Low stand-by consumption $\leq 0.2\text{ W}$
- Suitable for emergency lighting
- Very wide t_a range up to $-40...+54\text{ }^\circ\text{C}$
- $t_c \text{ max} = 85^\circ\text{C}$
- Very low ripple $\leq 1\%$
- Fully programmable, DALI/NFC
- 4kV surge protection
- 200'000 switching cycles
- 8 years guarantee @ $t_c \text{ max} -10^\circ\text{C}$

Electrical Specifications

	Item	Value	Unit	Remarks
INPUT	Nominal voltage	220 – 240	V	
	Nominal frequency	0 / 50 / 60	Hz	
	AC voltage range	198 – 264	V	AC or RAC
	DC voltage range	176 – 276	V	DC
	Maximum voltage	350	V _{AC}	2 h maximum, unit might not operate in this abnormal condition
	Nominal current	0.68	A	
	Total Harmonic Distortion (THD)	< 10	%	Typical value, full load
	Power factor	> 0.98		Full load, 220 – 240 V, 50 Hz / see graphs
	Efficiency (declared value)	Up to 95.5	%	Full load, 220 – 240 V, 50 Hz / see graphs
	Starting time	≤ 0.6	s	
	Stand-by power (declared value)	≤ 0.16	W	Typical value, 230V, 50Hz
	Power loss	11	W	Maximum full load
	Protection class	I		PE can be connected either to terminal or housing
	Inrush current	5	A pk	TH = 870µs
Max. units per circuit breaker	B16: 22; B10: 14			
PE current	< 0.5	mA	Through PE	
OUTPUT	Nominal voltage range	64 – 300	V	
	Maximum voltage	< 310	V _{DC}	w/ no load
	Nominal current range	250 – 1000	mA	Default output current: 250mA
	Current accuracy	+/- 3	%	
	Current ripple	< 1	%	LF ripple <1%, HF ripple <4%
	Nominal power range	43 – 150	W	
	PsT	≤ 1		At full load
	SVM	≤ 0.4		At full load
	Maximum power	150	W	
	DC Output current (EL)	15	%	Preset value, adjustable via software, at DC or RAC
	Galvanic isolation	No		Non-isolated
	Dimming control	Yes		DALI and TouchDIM
	Dimming range	1...100	%	Complete analogue Dimming
	Dimming standard	DALI-2		
ENVIRONMENT	Ambient temperature range t _a	-40 ...+65 -40 ...+60	°C	250-700mA > 700mA
	Maximum case temperature t _c	85	°C	Measured on t _c point indicated of the product label.
	Max. case temp. in fault condition	110	°C	
	Storage temperature range	-25 ...+85	°C	
	Relative humidity	5 ... 85	%	Not condensing
	Surge transient protection	4 4	kV	L/N LN/PE acc. To. EN 61547 Clause 5.7
	Environmental rating	Indoor		
	IP rating	IP 20		
	Mains switching cycles	> 200'000		
	Expected lifetime	50'000	hrs	t _c = 85°C, 0.2% / 1'000 h failure rate, 24h ON
100'000		t _c = 75°C, 0.1% / 1'000 h failure rate, 24h ON		

OPTOTRONIC® INTELLIGENT
OT/ DALI 150/220-240/A0 D NFC IND L
 Constant current LED Power Supply

Output	Power	Current	Voltage	Efficiency	THD	PF
250mA	150W	0.68A	220-240V	95.5%	<10%	>0.98
500mA	75W	0.34A	220-240V	95.5%	<10%	>0.98
1000mA	37.5W	0.17A	220-240V	95.5%	<10%	>0.98



Wiring Diagram

Terminal:
 Max. cable length - system:
 Geometrv (l x b x h):
 Weight:

Push in terminals
 2 m
 425 x 30 x 21 mm
 306g

Wire preparation:
 Push in
 s: 0.5-1.5
 f: 0.75-1.5
 7-8 mm

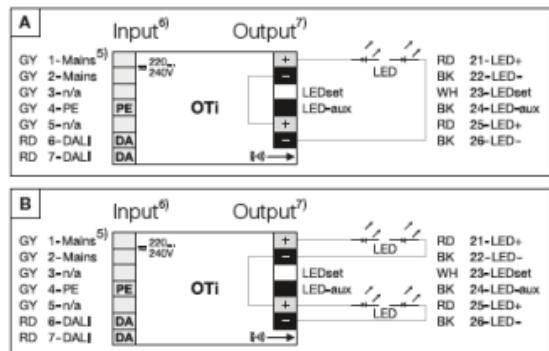

5.) Mains – 6.) Input – 7.) Output

Recommendations on how to dispose of it at the end of its life in line with Directive 2012/19/EU :

Separate control gear must be disposed of, in accordance with WEEE, at certified waste disposal companies. For this purpose, recycling centres and take-back systems (CRSO) collection points are available in the trade or at private disposal companies that accept separate control gears free of charge. In this way, raw materials are conserved, and materials are recycled.

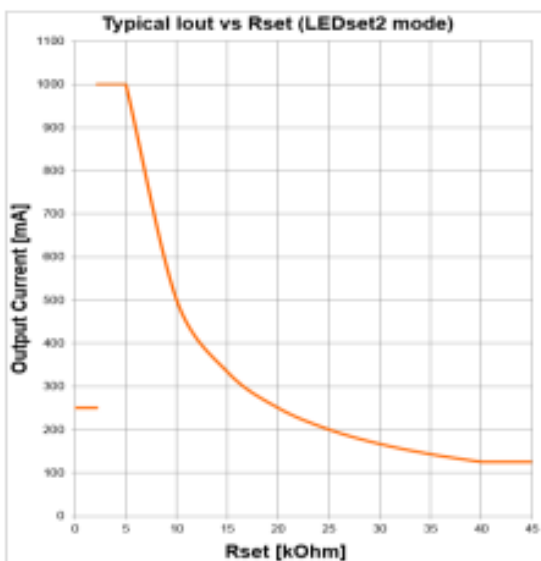
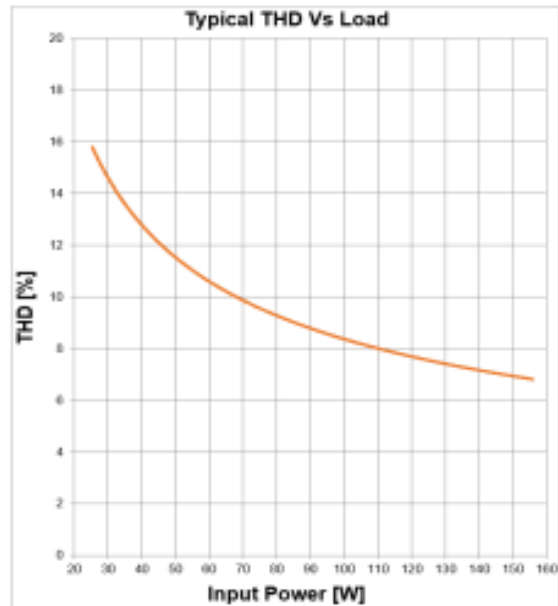
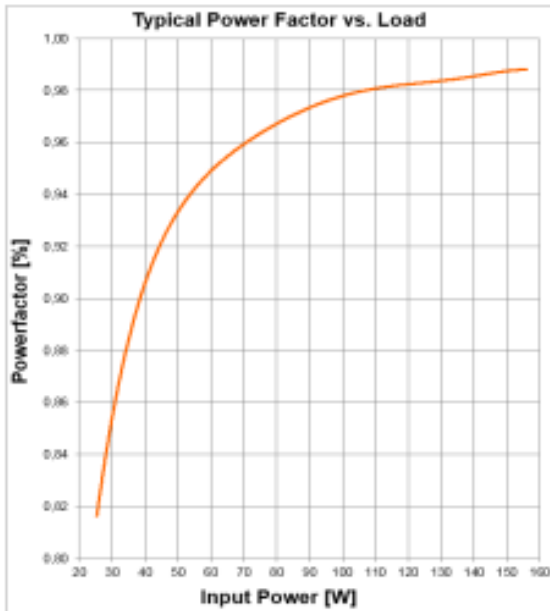
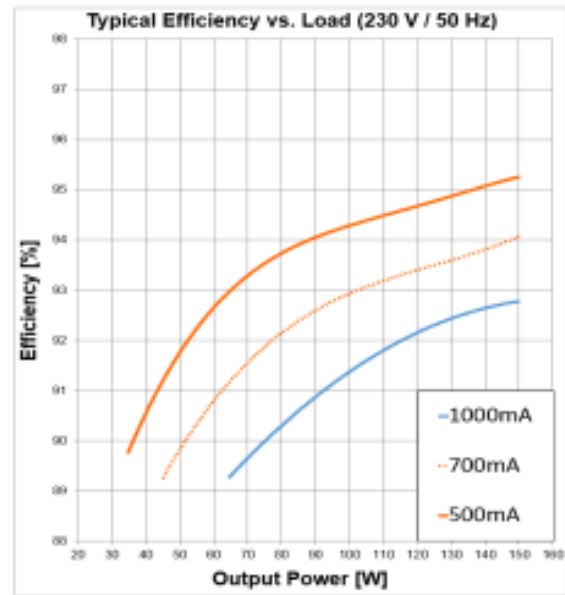
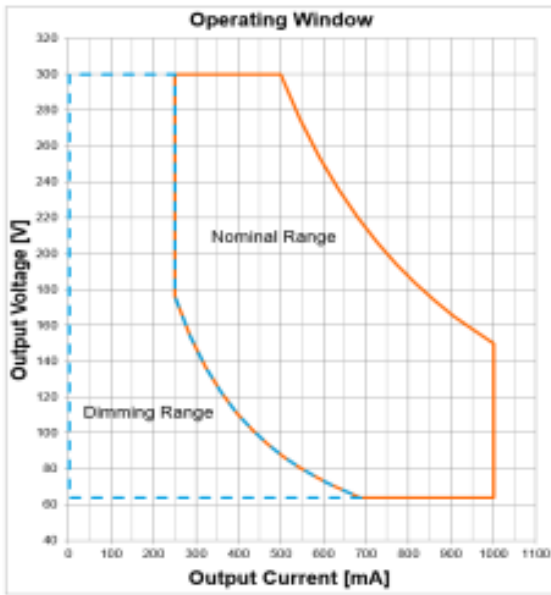

Additional Features

- Soft Switch Off (in analogue mode) – Driver Guard –
- Tuning Factor – Dim to Dark – Luminaire Info (Part 251) –
- Monitoring Data (Part 252&253) – Configuration Lock

Remarks – Operating the Control Gear:

- The control gear is designed for constant current LED light sources that fit into the operating window of the control gear
- Compatibility with light sources when dimming: The forward voltage must be within the operating window of the control gear in all dimming position
- The lamp control gear relies upon the luminaire enclosure for protection against accidental contact with living parts. Hot plug-in or secondary switching of LEDs is not permitted and may cause a very high current to the LEDs.
- The DALI terminal have basic insulation with LV supply voltage
- The control gear is not intended for use in luminaires for high-risk task area lighting
- Default EOFI is 0.15

Remarks – Protections & Behaviour:

- **Input overvoltage protection:** mains up to 350 Vac, for two hours maximum, will not destroy both the unit and the load; shut down of the load might occur in this condition.
- **Input surge protection:** the unit is protected against surge up to 4kV between L-N (symmetric surge) and 4kV between L/N-PE (asymmetric surge). During an asymmetric surge, the voltage between the LED outputs and PE is equal or lower than the applied surge voltage.
- **Output short circuit / undervoltage protection:** shut down of the load happens if V_{out} is out of the operating range. Non-reversible
- **Output overload protection:** the unit automatically reduces the output current to keep the output power below 150W. . Non-reversible
- **Output over voltage protection:** shut down of the load might happen if V_{out} exceeds 300V.
 - **Step 1:** output current reduction to decrease V_{out} ;
 - **Step 2:** shut down of the load at longer or extreme overvoltage.
- **No load operation:** the unit automatically switches off, the maximum output voltage is <310V.
- **Overtemperature protection:** the unit is protected against temporary overheating by automatic reduction of the output current when $t_c > 85^{\circ}\text{C}$.
- **Switchover time:** lower than 0.5 s, from AC to DC mains and viceversa.
- **Output power hold time:** > 4 ms, in case of mains dips.
- **Emergency lighting:** this LED power supply is suitable for emergency lighting fixtures acc. to IEC 60598-2-22; according to IEC 61347-2-13 Annex J.

Standards

IEC 61347-1
IEC 61347-2-13
IEC 62384
IEC 62386
IEC 61000-3-2
IEC 61000-3-3
IEC 61547

Ordering information

Product name	EAN10	NAED	Pieces / box
OTi DALI 150/220-240/1A0 D NFC IND L	4052899559530	n.a.	20

Data privacy

This OSRAM driver can be configured using the Tuner4TRONIC software. This requires registering on www.myosram.com and downloading the Tuner4TRONIC software from the Internet. The Tuner4TRONIC software enables users to access and view the operational data of a luminaire or driver via the corresponding programming interfaces. A password key (Config Lock) must be set up in the driver via the Tuner4TRONIC software in order to control which users can access and view operational data. Follow the instructions for password setup. To grant an external person or company rights to access or view operational data, you can assign password keys. In this case, however, you are responsible for ensuring that the third party concerned takes notice of the information described here. However, OSRAM can read out operating data from devices for maintenance and service purposes even when a password key has been assigned. In individual cases, OSRAM will also use its access rights in order to optimize or improve driver hardware and driver functions. In accordance with data privacy principles, any user of operating data (luminaire manufacturers, third parties with access rights) must ensure that personal data (e.g. name, address, location IDs) are only merged with the prior written consent of the person (end user) concerned. The respective user of the operating data is responsible for providing evidence of consent.

Inventronics GmbH

Head Office:

Parking 31-33
85478 Garching, Germany
www.inventronicsglobal.com

inventronics